



Sit Tight Sectional

Designed by Milo Baughman

Upholstery Options

Limited Fabric options for this style.
COM or graded in fabric must be pre approved.

Cushion Options

2.5 density foam and fiber seat and back is standard.

Base Options

Fully Upholstered base.

Stainless steel with metal finishes.
Custom powder coat finish - call for pricing.

Sectional connecting bracket available upon request.

Metal Finish Options



Polished
Stainless



Brushed
Bronze



Black
Powder Coat



White
Powder Coat

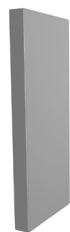

Grey
Powder Coat

Sit Tight Series

1/4" = 1'-0" (1:48) Scale
Dimensions are approximate and for schematic purposes only

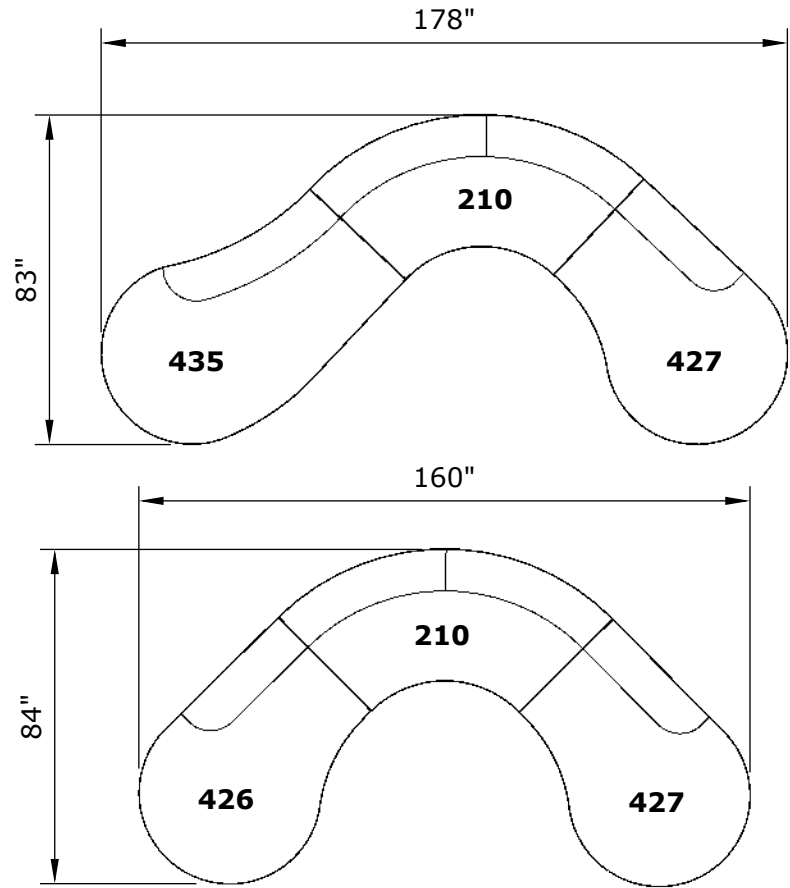
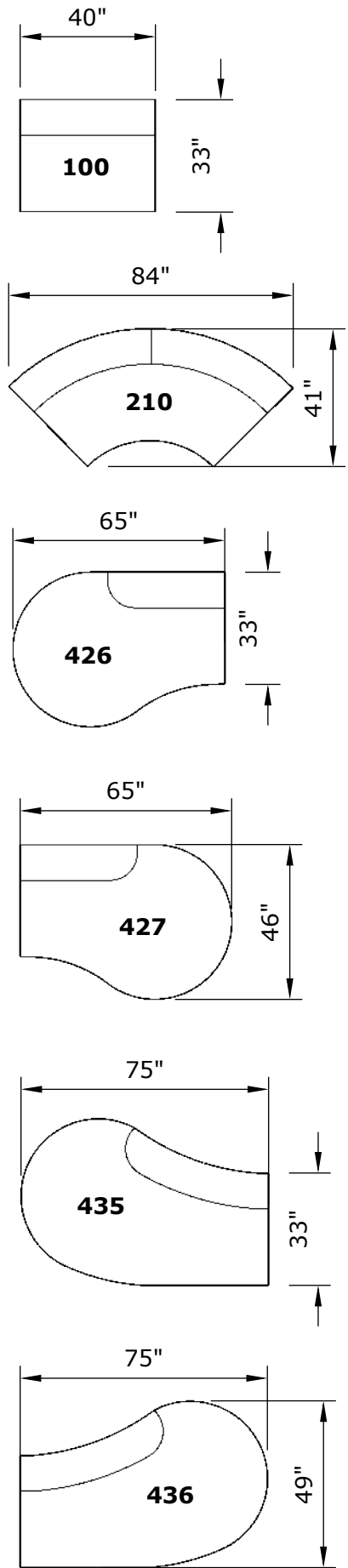

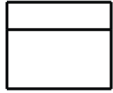

Sit Tight Armless Chair

Foam/Fiber Tight Seat
Foam/Fiber Tight Back

Model No.	W x D x H in	Seat Depth	Seat Height	Arm Height	Ydg	SqFt	lbs
C1500-100	40 x 33 x 32	22.5	19	N/A	8.5	170	N/A

Finish	AA	BB	CC
C1500-100 Upholstered	11872	12557	13237
C1500-100-PS Polished Stainless	11872	12557	13237
C1500-100-B Bronze	13132	13816	14498
C1500-100-BPC Black Powder Coat	13132	13816	14498
C1500-100-GPC Grey Powder Coat	13132	13816	14498
C1500-100-WPC White Powder Coat	13132	13816	14498

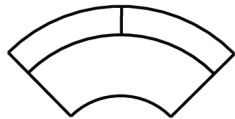

Sit Tight Curved Corner

Foam/Fiber Tight Seat
Foam/Fiber Tight Back

Model No.	W x D x H in	Seat Depth	Seat Height	Arm Height	Ydg	SqFt	lbs
C1500-210	84 x 41 x 32	22.5	19	N/A	13	260	N/A

Finish	AA	BB	CC
C1500-004 Upholstered	14289	15549	16809
C1500-004-PS Polished Stainless	14289	15549	16809
C1500-004-B Bronze	15549	16809	18070
C1500-004-BPC Black Powder Coat	15549	16809	18070
C1500-004-GPC Grey Powder Coat	15549	16809	18070
C1500-004-WPC White Powder Coat	15549	16809	18070

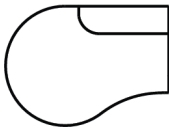

Sit Tight Left Bumper, Straight Back

Foam/Fiber Tight Seat
Foam/Fiber Tight Back

Model No.	W x D x H in	Seat Depth	Seat Height	Arm Height	Ydg	SqFt	lbs
C1500-426	65 x 46 x 32	22.5 - 35	19	N/A	13	260	N/A

Finish	AA	BB	CC
C1500-426 Upholstered	13868	15128	16390
C1500-426-PS Polished Stainless	13868	15128	16390
C1500-426-B Bronze	15128	16390	17651
C1500-426BPC Black Powder Coat	15128	16390	17651
C1500-426-GPC Grey Powder Coat	15128	16390	17651
C1500-426-WPC White Powder Coat	15128	16390	17651

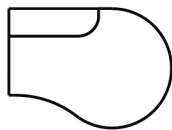

Sit Tight Right Bumper, Straight Back

Foam/Fiber Tight Seat
Foam/Fiber Tight Back

Model No.	W x D x H in	Seat Depth	Seat Height	Arm Height	Ydg	SqFt	lbs
C1500-427	65 x 46 x 32	22.5 - 35	19	N/A	13	260	N/A

Finish	AA	BB	CC
C1500-427 Upholstered	13868	15128	16390
C1500-427-PS Polished Stainless	13868	15128	16390
C1500-427-B Bronze	15128	16390	17651
C1500-427-BPC Black Powder Coat	15128	16390	17651
C1500-427-GPC Grey Powder Coat	15128	16390	17651
C1500-427-WPC White Powder Coat	15128	16390	17651

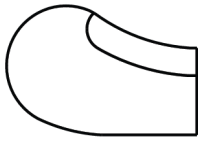

Sit Tight Left Bumper, Straight Back

Foam/Fiber Tight Seat
Foam/Fiber Tight Back

Model No.	W x D x H in	Seat Depth	Seat Height	Arm Height	Ydg	SqFt	lbs
C1500-435	75 x 49 x 32	22.5 - 35	19	N/A	12	240	N/A

Finish	AA	BB	CC
C1500-435 Upholstered	13868	15128	16390
C1500-435-PS Polished Stainless	13868	15128	16390
C1500-435-B Bronze	15128	16390	17651
C1500-435-BPC Black Powder Coat	15128	16390	17651
C1500-435-GPC Grey Powder Coat	15128	16390	17651
C1500-435-WPC White Powder Coat	15128	16390	17651

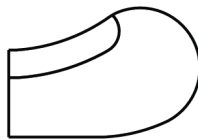

Sit Tight Right Bumper, Straight Back

Foam/Fiber Tight Seat
Foam/Fiber Tight Back

Model No.	W x D x H in	Seat Depth	Seat Height	Arm Height	Ydg	SqFt	lbs
C1500-436	75 x 49 x 32	22.5 - 35	19	N/A	12	240	N/A

Finish	AA	BB	CC
C1500-436 Upholstered	13868	15128	16390
C1500-436-PS Polished Stainless	13868	15128	16390
C1500-436-B Bronze	15128	16390	17651
C1500-436-BPC Black Powder Coat	15128	16390	17651
C1500-436-GPC Grey Powder Coat	15128	16390	17651
C1500-436-WPC White Powder Coat	15128	16390	17651